

VIKING



LA LAMA IN ACCIAIO CHE RICORDA IL PROFILO DI CHIGLIA DELLE NAVI VICHINGHE È LA SPINA DORSALE DI TUTTE LE SEDUTE CHE FANNO PARTE DELLA COLLEZIONE. SU DI ESSA SI INNESTANO IL FONDELLO LO SCHIENALE E GLI APPOGGI A TERRA. IL TELAIO È IN ACCIAIO, MENTRE I COMPONENTI DI SEDUTA E SCHIENALE SONO DISPONIBILI IN MULTISTRATO O CUOIO.

The steel blade recalling the contour of the keel of Viking ships is the backbone of all the chairs belonging to this collection. The chair seat, the backrest and the chair legs are inserted onto this. The chair frame is made of steel, while the seat and backrest are available in either plywood or leather.

La lame en acier qui rappelle le profil de la quille des navires vikings est l'épine dorsale de toutes les assises qui font partie de la collection. C'est sur elle que s'enclenchent le fond, le dossier et les appuis au sol. Le châssis est en acier alors que les composants de l'assise et du dossier sont disponibles en multicouche ou en cuir.

Ein Stahlprofil, das an den Rumpf der Wikingerschiffe erinnert, stellt das Rückgrat aller Stühle dieser Kollektion dar, an dem die Sitzfläche, die Rückenlehne und die Bodenstützen befestigt sind. Der Rahmen ist aus Stahl gefertigt, während die Sitzflächen und die Lehnen in Sperrholz oder Leder erhältlich sind.

La cuchilla de acero que recuerda el perfil de la quilla de los barcos vikingos, es la espina dorsal de todos los asientos que forman parte de la colección. Sobre ella, se ensamblan el fondo, el respaldo y los apoyos en el suelo. El bastidor es de acero, mientras que los componentes del asiento y el respaldo, están disponibles en madera estratificada o cuero.



Schienale adattivo
Adjustable backrest
Dossier adaptatif
Adaptive Rückenlehne
Respaldo adaptable



ADAPTIVE
CHAIR BACKREST
registered community
design













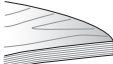





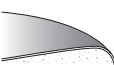









Sfoderabile
Removable upholstery
Déhoussable
Abnehmbares Polsterzeug
Cubierta desmontable



Piedini intercambiabili
Interchangeable feet
Pieds interchangeables
Austauschbare Füße
Pies intercambiables

FINITURE/FINISHES

fondello e schienale / seat and back

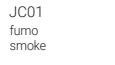
	essenze woods					
		Y36 rovere oak	Y34 noce walnut	Y37 rovere affumicato smoked oak	Y40 frassino argilla clay ash	Y39 frassino nero black ash
	cuoio cow-hide					
		F01 tabacco tobacco	F02 nero black			
	100% poliestere/polyester peso/weight: 400 gr/mq BSI : 50.000 cicli/cycles					
		JA01 perla pearl	JA02 avorio ivory	JA03 fango mud	JA04 salvia sage	JA05 oliva olive
	50% cotone/cotton 40% poliestere/polyester 10% poliacrilico/polyacrylic peso/weight: 430 gr/mq BSI : 40.000 cicli/cycles					
		JB01 natur natur	JB02 ecru ecru	JB03 grigio grey	JB04 cenere ash	JB05 platino platinum
	60% lino/linen 40% viscosa/viscose peso/weight: 550 gr/mq BSI : 20.000 cicli/cycles					
		JC01 fumo smoke	JC02 cenere ash	JC03 sacco sack	JC04 terra land	JC05 verde green
						
		JC06 rosa pink				

telaio / structure

	acciaio verniciato painted steel						
		C12 bianco white	C21 seta silk	C23 corda ecru	C30 ghisa cast-iron	C14 antracite anthracite	C08 nero black
							
		C18 verde green	C26 corten corten	C29 bronzo bronze	C37 rame copper	C38 titanio titanium	

DIMENSIONI/DIMENSIONS

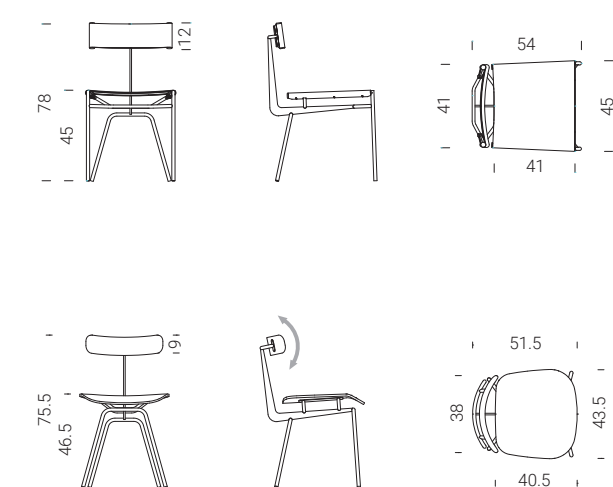

verificare a listino disponibilità, composizione e consigli di lavaggio per i tessuti.
check availability, composition and washing recommendations for fabrics in the price list.

01/VIKING K

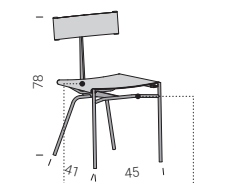

F02
cow-hide
black

C08
black

ATELIER pg. 46

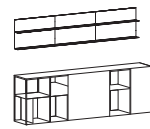

T8 pg. 224

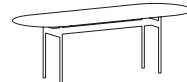

- VIKING K**
- ▶ Caratteristiche costruttive
 - ▶ Construction characteristics
 - ▶ Caractéristiques de construction
 - ▶ Konstruktionsmerkmale
 - ▶ Características constructivas

06/VIKING K

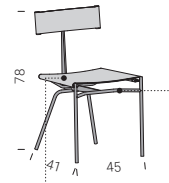

F01
cow-hide
tobacco

C08
black



T9 pg. 234



07/VIKING W



Y39 black ash
C08 black



05/VIKING W



Y34 walnut
C08 black
F01 cow-hide tobacco



- VIKING W**
- Caratteristiche costruttive
 - Construction characteristics
 - Caractéristiques de construction
 - Konstruktionsmerkmale
 - Características constructivas



T9 pg. 234



URANO pg. 388

